

Note: to be plasma cut

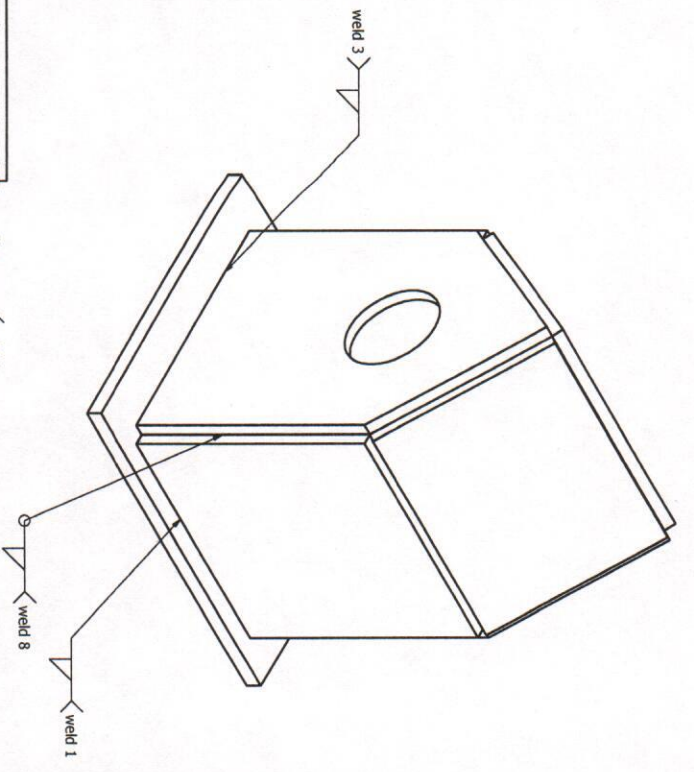

DRAWN	2/21/2017	TITLE	
STUDENT		SIZE	DWG NO
CHECKED		C	Isometric-1
QA		SCALE	SHEET 1 OF 1
MFG			
APPROVED			
			REV

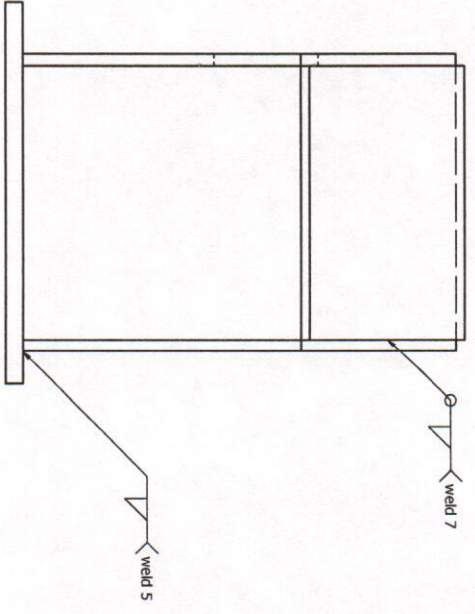
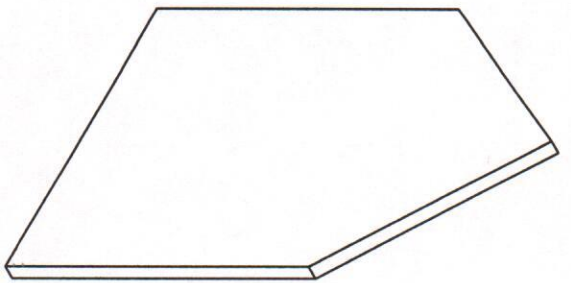
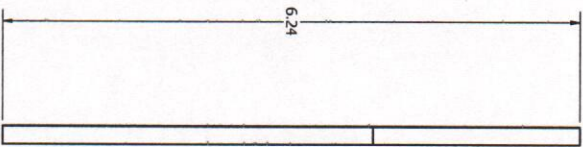
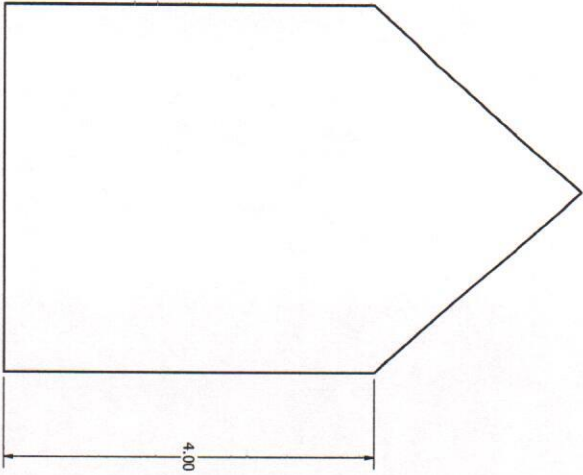
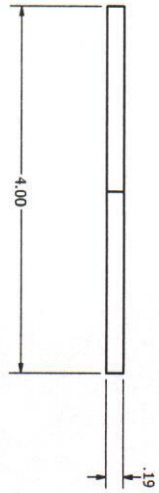

DRAWN	2/21/2017	TITLE	
STUDENT			
CHECKED			
QA			
MFG			
APPROVED			
SIZE	C	DWG NO	back
SCALE			

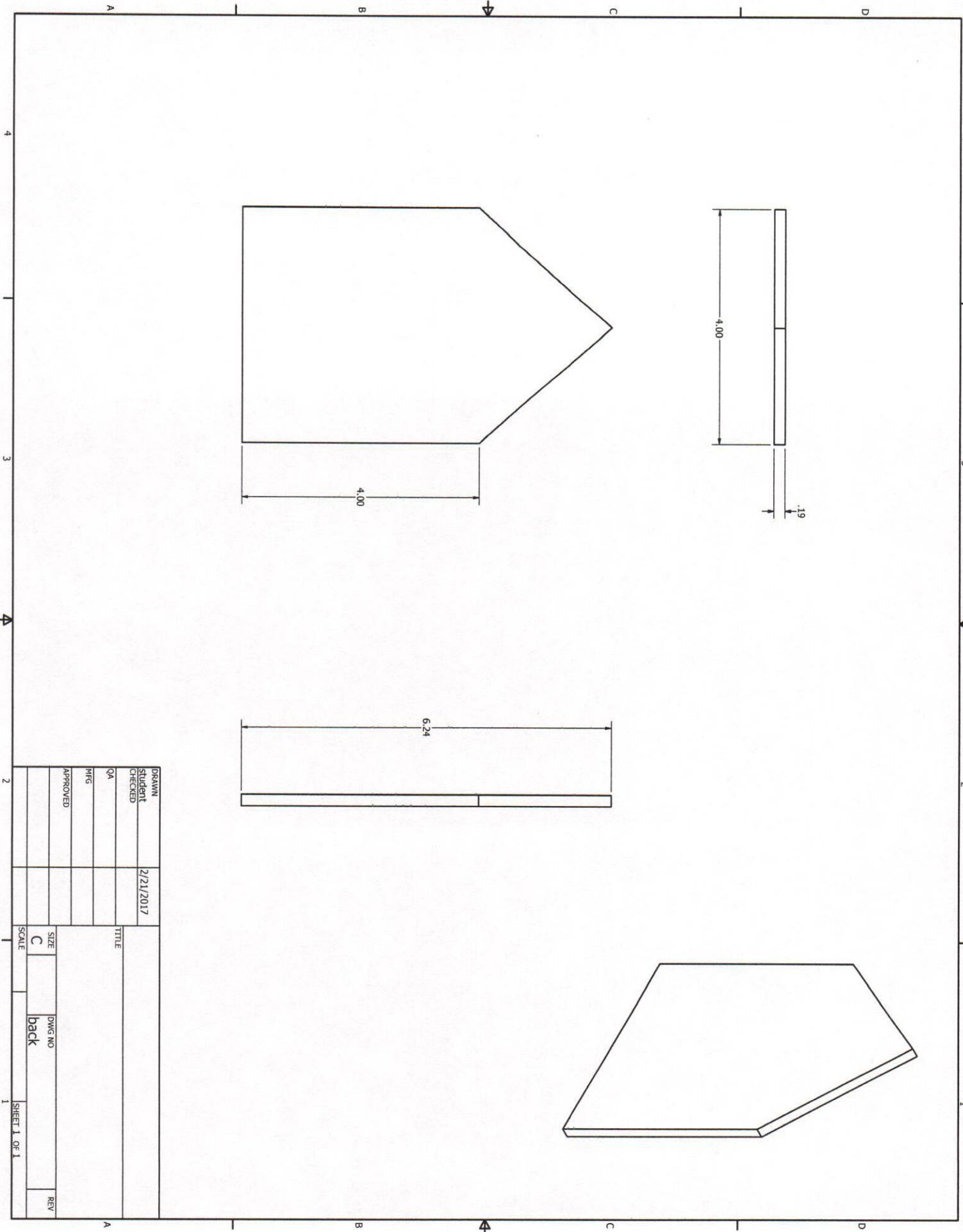

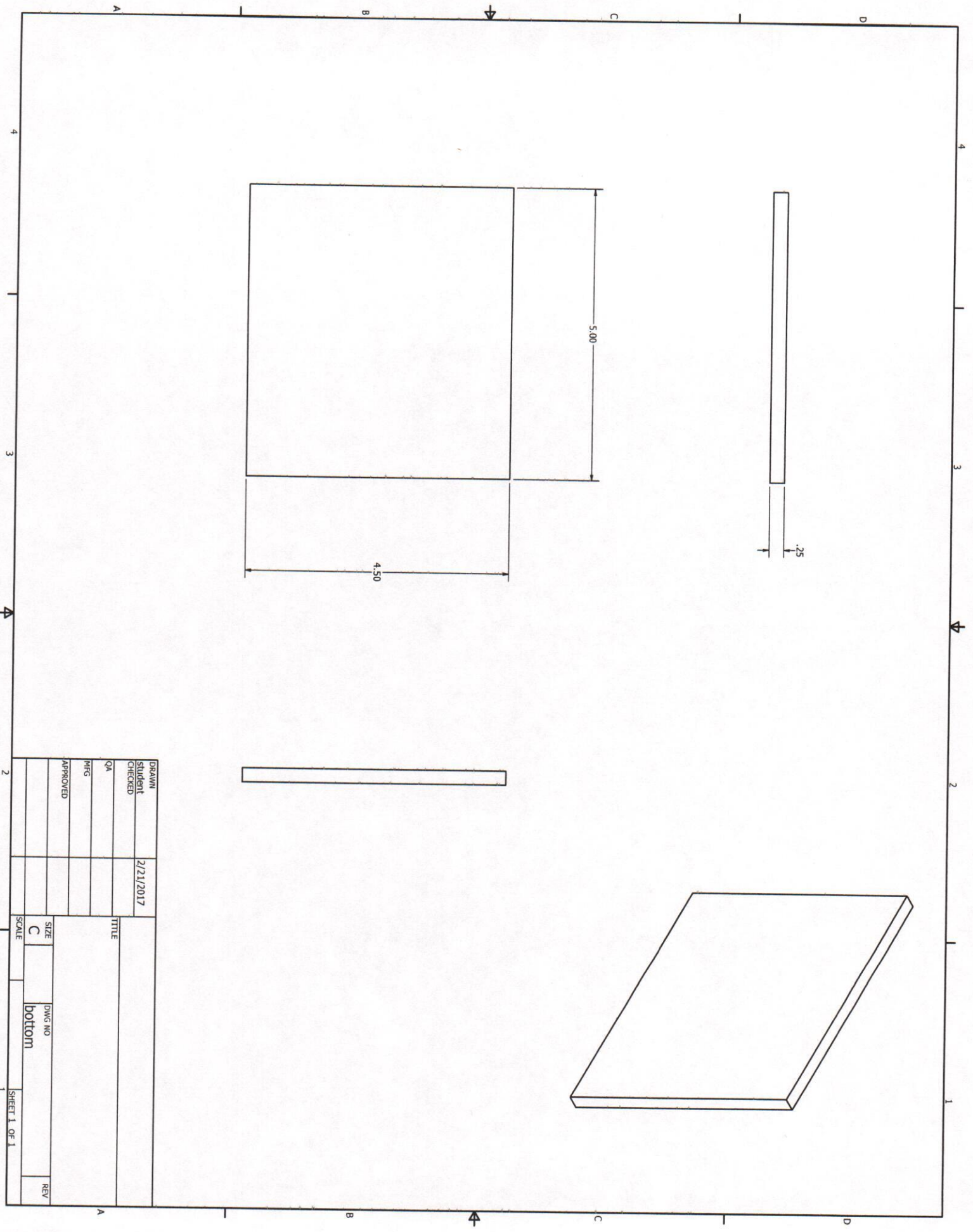

DRAWN	2/21/2017	TITLE	
STUDENT		SIZE	C
CHECKED		SCALE	
QA		DWG. NO.	bottom
MFG		REV	
APPROVED			

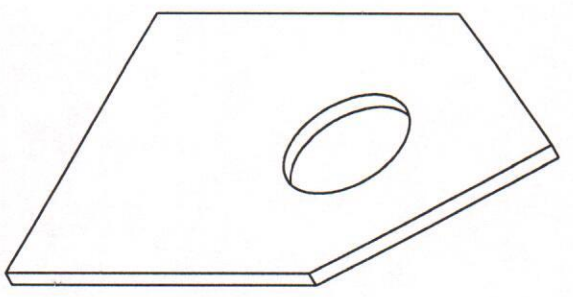
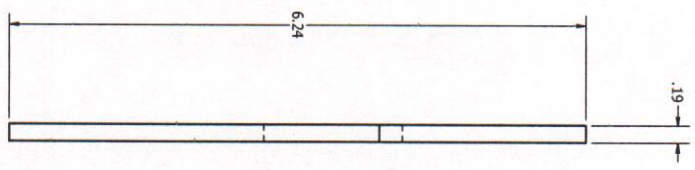
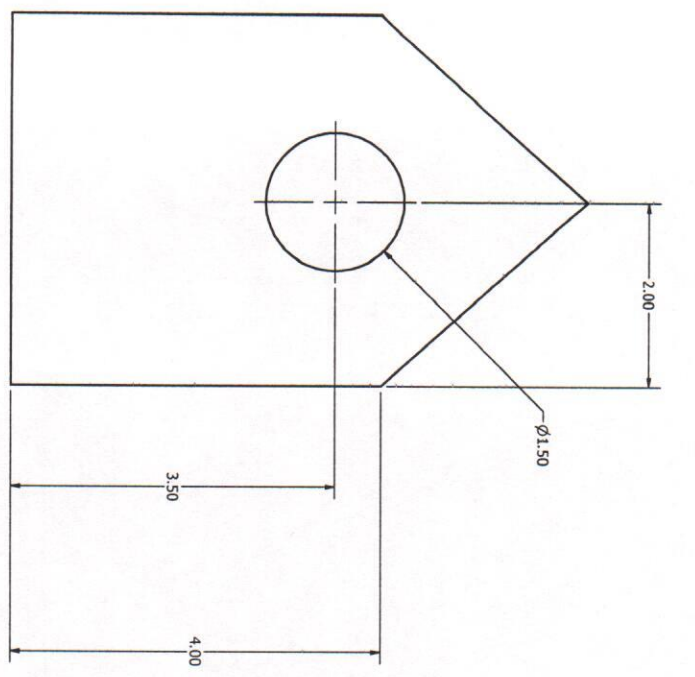
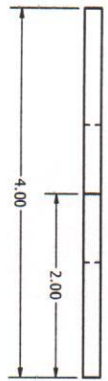

DRAWN	Student	DATE	2/21/2017
CHECKED		TITLE	
QA		SIZE	C
MFG		DWG NO	Part4
APPROVED		SCALE	
		REV	

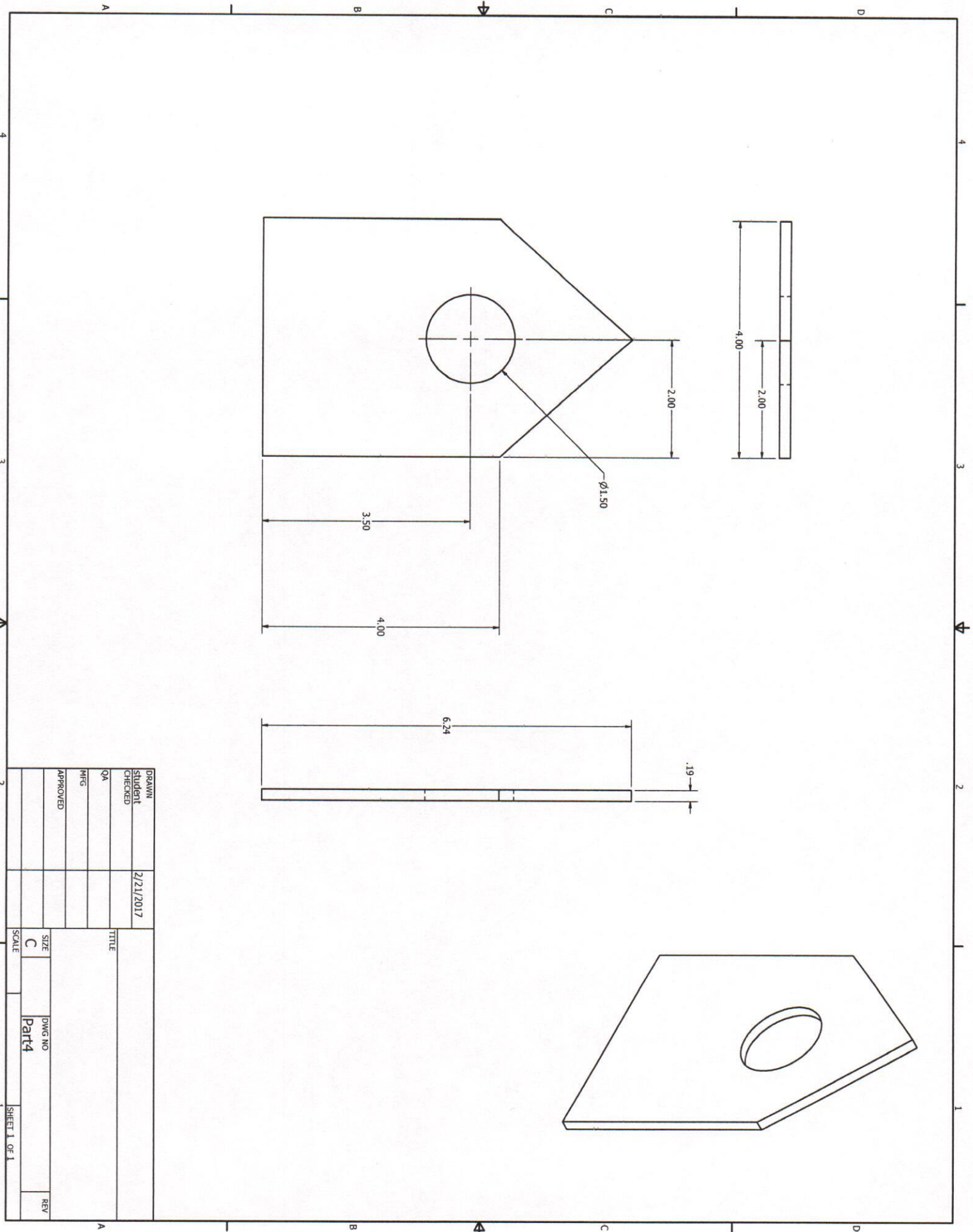

SHEET 1 OF 1

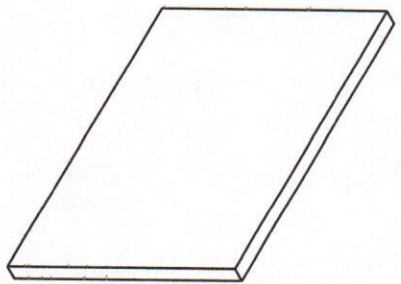
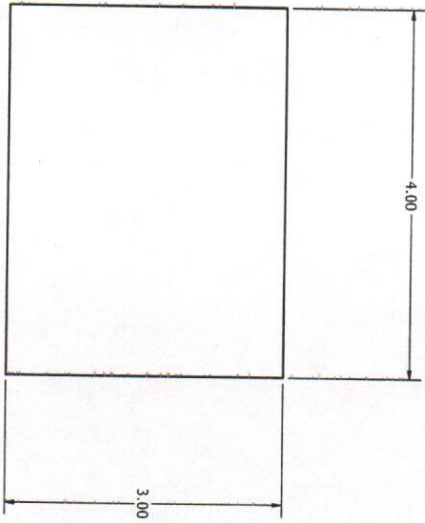

DRAWN		2/21/2017	TITLE	
STUDENT				
CHECKED				
QA				
MFG				
APPROVED				
SIZE	C	DWG NO	side top	REV
SCALE				

